

EOE7C31X
EOE7C31Z
EOE7C31V



EN Oven

User Manual



Electrolux

CONTENTS

1. SAFETY INFORMATION.....	3
2. SAFETY INSTRUCTIONS.....	4
3. PRODUCT DESCRIPTION.....	7
4. CONTROL PANEL.....	7
5. BEFORE FIRST USE.....	9
6. DAILY USE.....	9
7. CLOCK FUNCTIONS.....	11
8. AUTOMATIC PROGRAMMES.....	13
9. USING THE ACCESSORIES.....	14
10. ADDITIONAL FUNCTIONS.....	17
11. HINTS AND TIPS.....	18
12. CARE AND CLEANING.....	31
13. TROUBLESHOOTING.....	34
14. INSTALLATION.....	36
15. ENERGY EFFICIENCY.....	37

WE'RE THINKING OF YOU

Thank you for purchasing an Electrolux appliance. You've chosen a product that brings with it decades of professional experience and innovation. Ingenious and stylish, it has been designed with you in mind. So whenever you use it, you can be safe in the knowledge that you'll get great results every time.

Welcome to Electrolux.

Visit our website for:



Get usage advice, brochures, trouble shooter, service information:
www.electrolux.com/webselfservice



Register your product for better service:
www.registerelectrolux.com



Buy Accessories, Consumables and Original spare parts for your appliance:
www.electrolux.com/shop

CUSTOMER CARE AND SERVICE

Always use original spare parts.

When contacting our Authorised Service Centre, ensure that you have the following data available: Model, PNC, Serial Number.

The information can be found on the rating plate.

 Warning / Caution-Safety information

 General information and tips

 Environmental information

Subject to change without notice.

1. ⚠️ SAFETY INFORMATION

Before the installation and use of the appliance, carefully read the supplied instructions. The manufacturer is not responsible for any injuries or damages that are the result of incorrect installation or usage. Always keep the instructions in a safe and accessible location for future reference.

1.1 Children and vulnerable people safety

- This appliance can be used by children aged from 8 years and above and persons with reduced physical, sensory or mental capabilities or lack of experience and knowledge if they have been given supervision or instruction concerning the use of the appliance in a safe way and understand the hazards involved.
- Children between 3 and 8 years of age and persons with very extensive and complex disabilities shall be kept away unless continuously supervised.
- Children of less than 3 years of age should be kept away unless continuously supervised.
- Do not let children play with the appliance.
- Keep all packaging away from children and dispose of it appropriately.
- Keep children and pets away from the appliance when it operates or when it cools down. Accessible parts are hot.
- If the appliance has a child safety device, it should be activated.
- Children shall not carry out cleaning and user maintenance of the appliance without supervision.

1.2 General Safety

- Only a qualified person must install this appliance and replace the cable.
- **WARNING:** The appliance and its accessible parts become hot during use. Care should be taken to avoid touching heating elements.

- Always use oven gloves to remove or put in accessories or ovenware.
- Before carrying out any maintenance, disconnect the appliance from the power supply.
- Ensure that the appliance is switched off before replacing the lamp to avoid the possibility of electric shock.
- Do not use a steam cleaner to clean the appliance.
- Do not use harsh abrasive cleaners or sharp metal scrapers to clean the glass door since they can scratch the surface, which may result in shattering of the glass.
- If the mains power supply cable is damaged, it must be replaced by the manufacturer, its Authorised Service Centre or similarly qualified persons to avoid an electrical hazard.
- To remove the shelf supports first pull the front of the shelf support and then the rear end away from the side walls. Install the shelf supports in the opposite sequence.
- Use only the food sensor (core temperature sensor) recommended for this appliance.

2. SAFETY INSTRUCTIONS

2.1 Installation



WARNING!

Only a qualified person must install this appliance.

- Remove all the packaging.
- Do not install or use a damaged appliance.
- Follow the installation instructions supplied with the appliance.
- Always take care when moving the appliance as it is heavy. Always use safety gloves and enclosed footwear.
- Do not pull the appliance by the handle.
- Keep the minimum distance from other appliances and units.

- Install the appliance in a safe and suitable place that meets installation requirements.
- The appliance is equipped with an electric cooling system. It must be operated with the electric power supply.

2.2 Electrical connection



WARNING!

Risk of fire and electric shock.

- All electrical connections should be made by a qualified electrician.
- The appliance must be earthed.
- Make sure that the parameters on the rating plate are compatible with the

- electrical ratings of the mains power supply.
- Always use a correctly installed shockproof socket.
 - Do not use multi-plug adapters and extension cables.
 - Make sure not to cause damage to the mains plug and to the mains cable. Should the mains cable need to be replaced, this must be carried out by our Authorised Service Centre.
 - Do not let mains cables touch or come near the appliance door, especially when the door is hot.
 - The shock protection of live and insulated parts must be fastened in such a way that it cannot be removed without tools.
 - Connect the mains plug to the mains socket only at the end of the installation. Make sure that there is access to the mains plug after the installation.
 - If the mains socket is loose, do not connect the mains plug.
 - Do not pull the mains cable to disconnect the appliance. Always pull the mains plug.
 - Use only correct isolation devices: line protecting cut-outs, fuses (screw type fuses removed from the holder), earth leakage trips and contactors.
 - The electrical installation must have an isolation device which lets you disconnect the appliance from the mains at all poles. The isolation device must have a contact opening width of minimum 3 mm.
 - This appliance complies with the E.E.C. Directives.
- Deactivate the appliance after each use.
 - Be careful when you open the appliance door while the appliance is in operation. Hot air can release.
 - Do not operate the appliance with wet hands or when it has contact with water.
 - Do not apply pressure on the open door.
 - Do not use the appliance as a work surface or as a storage surface.
 - Open the appliance door carefully. The use of ingredients with alcohol can cause a mixture of alcohol and air.
 - Do not let sparks or open flames to come in contact with the appliance when you open the door.
 - Do not put flammable products or items that are wet with flammable products in, near or on the appliance.

**WARNING!**

Risk of damage to the appliance.

2.3 Use

**WARNING!**

Risk of injury, burns and electric shock or explosion.

- This appliance is for household use only.
- Do not change the specification of this appliance.
- Make sure that the ventilation openings are not blocked.
- Do not let the appliance stay unattended during operation.
- To prevent damage or discoloration to the enamel:
 - do not put ovenware or other objects in the appliance directly on the bottom.
 - do not put aluminium foil directly on the bottom of cavity of the appliance.
 - do not put water directly into the hot appliance.
 - do not keep moist dishes and food in the appliance after you finish the cooking.
 - be careful when you remove or install the accessories.
- Discoloration of the enamel or stainless steel has no effect on the performance of the appliance.
- Use a deep pan for moist cakes. Fruit juices cause stains that can be permanent.
- This appliance is for cooking purposes only. It must not be used for other purposes, for example room heating.
- Always cook with the oven door closed.
- If the appliance is installed behind a furniture panel (e.g. a door) make

sure the door is never closed when the appliance is in operation. Heat and moisture can build up behind a closed furniture panel and cause subsequent damage to the appliance, the housing unit or the floor. Do not close the furniture panel until the appliance has cooled down completely after use.

2.4 Care and cleaning



WARNING!

Risk of injury, fire, or damage to the appliance.

- Before maintenance, deactivate the appliance and disconnect the mains plug from the mains socket.
- Make sure the appliance is cold. There is the risk that the glass panels can break.
- Replace immediately the door glass panels when they are damaged. Contact the Authorised Service Centre.
- Be careful when you remove the door from the appliance. The door is heavy!
- Clean regularly the appliance to prevent the deterioration of the surface material.
- Clean the appliance with a moist soft cloth. Only use neutral detergents. Do not use any abrasive products, abrasive cleaning pads, solvents or metal objects.
- If you use an oven spray, follow the safety instruction on it's packaging.

- Do not clean the catalytic enamel (if applicable) with any kind of detergent.

2.5 Internal lighting



WARNING!

Risk of electric shock.

- The type of light bulb or halogen lamp used for this appliance is for household appliances only. Do not use it for house lighting.
- Before replacing the lamp, disconnect the appliance from the power supply.
- Only use lamps with the same specifications.

2.6 Service

- To repair the appliance contact an Authorised Service Centre.
- Use original spare parts only.

2.7 Disposal



WARNING!

Risk of injury or suffocation.

- Disconnect the appliance from the mains supply.
- Cut off the mains electrical cable close to the appliance and dispose of it.
- Remove the door catch to prevent children or pets from becoming trapped in the appliance.

3. PRODUCT DESCRIPTION

3.1 General overview

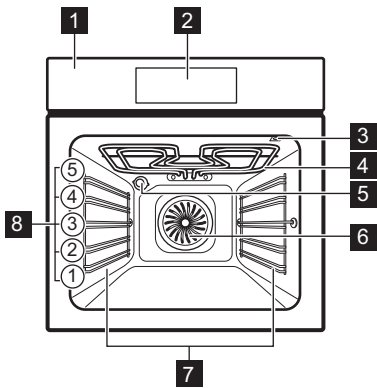

- 1 Control panel
- 2 Electronic programmer
- 3 Socket for the core temperature sensor
- 4 Heating element
- 5 Lamp
- 6 Fan
- 7 Shelf support, removable
- 8 Shelf positions

3.2 Accessories

- **Wire shelf**
For cookware, cake tins, roasts.
- **Baking tray**
For cakes and biscuits.
- **Grill- / Roasting pan**
To bake and roast or as pan to collect fat.

- **Core temperature sensor**
To measure how far the food is cooked.
- **Telescopic runners**
For shelves and trays.







4. CONTROL PANEL

4.1 Electronic programmer



Use the sensor fields to operate the appliance.

Sensor Field	Function	Description
1	ON / OFF	To turn the oven on and off.
2	OPTIONS	To set a heating function, a cleaning function or an automatic programme.



Sensor Field	Function	Description
3 	OVEN LIGHT	To turn the oven lamp on and off.
4 	TEMPERATURE / FAST HEAT UP	To set and examine the cavity temperature or the core temperature sensor temperature (if present). If you press it and hold for three seconds, it turns the Fast heat up function ON and OFF.
5 	MY FAVOURITE PROGRAMME	To store your favourite programme. Use it to access your favourite programme directly, also when the oven is off.
6 -	DISPLAY	Shows the current settings of the oven.
7 	UP	To move up in the menu.
8 	DOWN	To move down in the menu.
9 	CLOCK	To set the clock functions.
10 	MINUTE MINDER	To set the Minute Minder.
11 OK	OK	To confirm the selection or setting.

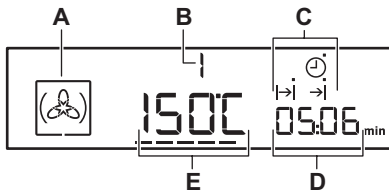



4.2 Display



- A. Heating function symbol
- B. Number of the heating function / programme
- C. Indicators for the clock functions (refer to "Clock functions" table)
- D. Clock / residual heat display
- E. Temperature / time of day display

Other indicators of the display:

Symbol	Name	Description
	Automatic programme	You can choose an automatic programme.
	My favourite programme	The favourite programme works.

Symbol	Name	Description
kg / g	kg / g	An automatic programme with weight input works.
h / min	h / min	A clock function works.
---	Heat-up / residual heat indicator	Shows the temperature level of the oven.
	Temperature / fast heat up	The function works.
	Temperature	You can examine or change the temperature.
	Core temperature sensor	The core temperature sensor is in the core temperature sensor socket.
	Minute minder	The minute minder function works.

4.3 Heat up indicator

If you turn on the heating function, --- appears. The bars show that the temperature in the oven increases or decreases.

When the oven is at the set temperature, the bars go off the display.

5. BEFORE FIRST USE



WARNING!
Refer to Safety chapters.



To set the Time of day refer to "Clock functions" chapter.

5.1 Initial Cleaning

Remove all accessories and removable shelf supports from the oven.



Refer to "Care and cleaning" chapter.

Clean the oven and the accessories before the first use.

Put the accessories and the removable shelf supports back to their initial position.

5.2 Preheating

Preheat the empty oven before first use.





1. Set the function:  and the maximum temperature.
2. Let the oven operate for 1 hour.
3. Set the function  and the maximum temperature.
4. Let the oven operate for 15 minutes. Accessories can become hotter than usual. The oven can emit an odour and smoke during preheating. Make sure that the airflow in the room is sufficient.





6. DAILY USE





WARNING!
Refer to Safety chapters.





6.1 Heating functions

Oven function	Application
 True Fan Cooking	To bake on up to three shelf positions at the same time and to dry food. Set the temperature 20 - 40 °C lower than for Conventional Cooking.
 Pizza Setting	To bake pizza. To make intensive browning and a crispy bottom.
 Conventional Cooking (Top / Bottom Heat)	To bake and roast food on one shelf position.
 Slow Cooking	To prepare tender, succulent roasts.
 Bottom Heat	To bake cakes with crispy bottom and to preserve food.



Oven function	Application
 Moist Fan Baking	This function is designed to save energy during cooking. For the cooking instructions refer to "Hints and tips" chapter, Moist Fan Baking. The oven door should be closed during cooking so that the function is not interrupted and to ensure that the oven operates with the highest energy efficiency possible. When you use this function, the temperature in the cavity may differ from the set temperature. The residual heat is used. The heating power may be reduced. For general energy saving recommendations refer to "Energy Efficiency" chapter, Energy Saving. This function was used to comply with the energy efficiency class according to EN 60350-1. When you use this function the lamp automatically turns off after 30 seconds.
 Defrost	To defrost food (vegetables and fruit). The defrosting time depends on the amount and size of the frozen food.
 Keep Warm	To keep food warm.
 Grilling	To grill flat food and to toast bread.

Oven function	Application
 Fast Grilling	To grill flat food in large quantities and to toast bread.
 Turbo Grilling	To roast larger meat joints or poultry with bones on one shelf position. To make gratins and to brown.

6.2 Setting the heating function



- Turn on the oven with .
The display shows the set temperature, the symbol and the number of the heating function.
- Press  or  to set a heating function.
- Press  or the oven starts automatically after 5 seconds.
If you turn on the oven and do not set any heating function or programme, the oven turns off automatically after 20 seconds.

6.3 Changing the temperature

Press  or  to change the temperature in steps: 5 °C.
When the oven is at the set temperature a signal sounds and the Heat up indicator disappears.

6.4 Checking the temperature

You can check the current temperature in the oven when the function or programme works.

- Press .
The display shows the temperature in the oven.
- Press  or the display shows again the set temperature automatically after 5 seconds.

6.5 Fast heat up

 Do not put food in the oven when the Fast heat up operates.





The Fast heat up is available only for some oven functions. If Faulty tone is turned on in the settings menu, the signal sounds if the Fast heat up is not available for the set function. Refer to "Additional functions" chapter, Using the settings menu.

The Fast heat up decreases the heat up time.

To turn on the Fast heat up press and hold  for more than 3 seconds.
If the Fast heat up is turned on the display shows: flashing horizontal bars

7. CLOCK FUNCTIONS





7.1 Clock functions table

Clock function	Application
 TIME OF DAY	To show or change the time of day. You can change the time of day only when the oven is on.
 DURATION	To set how long the oven works.
 END	To set when the oven turns off.
 TIME DELAY	To combine DURATION and END function.



Clock function	Application
 MINUTE MINDER	To set a countdown time. This function has no effect on the operation of the oven. You can set the MINUTE MINDER at any time and also when the oven is off.
00:00 COUNT UP TIMER	To set the count up, which shows how long the oven works. This function has no effect on the operation of the oven. It is on immediately when the oven starts to heat. The COUNT UP TIMER is not turned on if DURATION and END are set.

7.2 Setting and changing the time







After the first connection to the mains, wait until the display shows **h** and **12:00**. "12" flashes.

1. Touch  or  to set the hours.
2. Touch **OK**.
3. Touch  or  to set the minutes.
4. Touch **OK** or .

The display shows the new time.

To change the time of day touch  again and again until  starts to flash.





7.3 Setting the DURATION

1. Set a heating function and temperature.
2. Press  again and again until  starts to flash.
3. Use  or  to set the minutes for DURATION time.
4. Press **OK** or the DURATION time starts automatically after 5 seconds.
5. Use  or  to set the hours for DURATION time.
6. Press **OK**. The DURATION time starts automatically after 5 seconds.

When the set time ends, the signal sounds for 2 minutes.  and time setting flash in the display. The oven turns off.

7. Press a sensor field to stop the signal.
8. Turn off the oven.







7.4 Setting the END

1. Set an oven function and temperature.
2. Touch  again and again until  starts to flash.
3. Use  or  to set the END and **OK** to confirm. First you set the minutes and then the hours.



When the set time ends, an acoustic signal sounds for 2 minutes.  and the time setting flash in the display. The appliance deactivates automatically.

4. Touch a sensor field to stop the acoustic signal.
5. Turn off the appliance.

7.5 Setting the TIME DELAY function

1. Set an oven function and temperature.
2. Touch  again and again until  starts to flash.
3. Use  or  to set the minutes for DURATION.
4. Touch **OK**.
5. Use  or  to set the hours for DURATION.
6. Touch **OK**, the appliance switches to the setting of the END function.

The display shows flashing .

7. Use  or  to set the END and **OK** to confirm. First you set the minutes and then the hours.

Appliance turns on automatically later on, works for the set DURATION time and stops at the set END time. At the set time an acoustic signal sounds for 2 minutes.

→| and the time setting flash in the display. The appliance deactivates automatically.

8. Touch a sensor field to stop the acoustic signal.
9. Turn off the appliance.







When the Time delay function is activated, the display shows a static symbol of the oven function, |→| with a dot and →|. The dot shows which clock function is on in the Clock / residual heat display.



7.6 Setting the MINUTE MINDER

1. Touch .

 and "00" flash in the display.

2. Use  to switch between options. First you set the seconds, then the minutes and the hours.
3. Use  or  to set the MINUTE MINDER and  to confirm.
4. Touch OK or the MINUTE MINDER starts automatically after 5 seconds. When the set time ends, an acoustic signal sounds for 2 minutes and 00:00 and  flash in the display.
5. Touch a sensor field to stop the acoustic signal.

7.7 COUNT UP TIMER

1. To reset the Count Up Timer press:  and  at the same time .
2. When the display shows "00:00" the Count Up Timer starts to count up again.

8. AUTOMATIC PROGRAMMES



WARNING!
Refer to Safety chapters.





There are 9 automatic programmes. Use an automatic programme or recipe when

you do not have the knowledge or experience on how to prepare a dish. The display shows the default cooking times for all automatic programmes.

8.1 Automatic programmes



Programme number	Programme name
1	ROAST BEEF
2	ROAST PORK
3	CHICKEN, WHOLE
4	PIZZA
5	MUFFINS
6	QUICHE LORRAINE
7	WHITE BREAD
8	POTATO GRATIN
9	LASAGNE

8.2 Automatic programmes





1. Activate the appliance.
2. Touch .
The display shows the number of the automatic programme (1 – 9).
3. Touch  or  to choose the automatic programme.
4. Touch  or wait five seconds until the appliance automatically starts to work.
5. When the set time ends, an acoustic signal sounds for two minutes. The symbol  flashes.
6. Touch a sensor field to stop the acoustic signal.
7. Deactivate the appliance.

8.3 Automatic programmes with weight input

If you set the weight of the meat, the appliance calculates the roasting time.

1. Activate the appliance.
2. Touch .
3. Touch  or  to set the weight programme.



The display shows: the cooking time, the duration symbol , a default weight, a unit of measurement (kg, g).



4. Touch  or the settings save automatically after five seconds. The appliance activates.
5. You can change the default weight value with  or . Touch .



6. When the set time ends, an acoustic signal sounds for two minutes.  flashes.
7. Touch a sensor field to stop the acoustic signal.
8. Deactivate the appliance.

8.4 Automatic programmes with the core temperature sensor (selected models)

The core temperature of the food is default and fixed in programmes with the core temperature sensor. The programme ends when the appliance is at the set core temperature.

1. Activate the appliance.
2. Touch .
3. Install the core temperature sensor. Refer to "Core temperature sensor".
4. Touch  or  to set the programme for the core temperature sensor.

The display shows the cooking time,  and .

5. Touch  or the settings save automatically after five seconds. When the set time ends, an acoustic signal sounds for two minutes.  flashes.
6. Touch a sensor field or open the door to stop the acoustic signal.
7. Deactivate the appliance.

9. USING THE ACCESSORIES



WARNING!

Refer to Safety chapters.

9.1 Core temperature sensor

There are two temperatures to be set: the oven temperature and the core temperature.

The core temperature sensor measures the core temperature of the meat. When

the meat is at the set temperature, the appliance deactivates.



CAUTION!

Only use the core temperature sensor supplied or the correct replacement parts.





The core temperature sensor must stay in the meat and in the socket during the cooking.

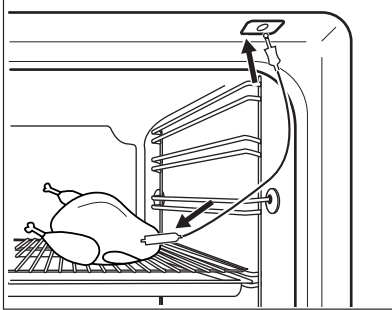





1. Activate the appliance.
2. Put the point of the core temperature sensor (with  on the handle) into the centre of the meat.
3. Put the plug of the core temperature sensor into the socket at the top of the cavity.



The display shows  flashing and the default set core temperature. The temperature is 60 °C for the first operation, and the last set value for each subsequent operation.

 When you put the core temperature sensor into the socket, you cancel the settings for the clock functions.

4. Touch  or  to set the core temperature.
5. Touch **OK** or the settings save automatically after 5 seconds.

 You can set the core temperature only when  flashes. If  is in the display but does not flash before you set the core temperature, touch  and  or  to set a new value.

6. Set the oven function and the oven temperature.

The display shows the current core temperature and the heat up symbol

While the appliance calculates the approximate duration time, the display shows the count up time. After the first calculation the display shows the

approximate duration of the cooking time.

The appliance continues to calculate the duration during the cooking. The display updates at intervals with the new duration value.

 When you cook with the core temperature sensor, you can change the temperature shown in the display. After you put the core temperature sensor in the socket and set an oven function and temperature, the display shows the current core temperature.

Touch  again and again to see three other temperatures:

- the set core temperature
- the current oven temperature
- the current core temperature.

When the meat is at the set core temperature, an acoustic signal sounds for two minutes and the value of the core temperature and  flash. The appliance deactivates.

7. Touch a sensor field to deactivate the acoustic signal.
8. Remove the core temperature sensor from the socket and remove the meat from the appliance.



WARNING!

Be careful when you remove the core temperature sensor. It is hot. There is a risk of burns.

9.2 Inserting the accessories

Wire shelf:

Push the shelf between the guide bars of the shelf support and make sure that the feet point down.

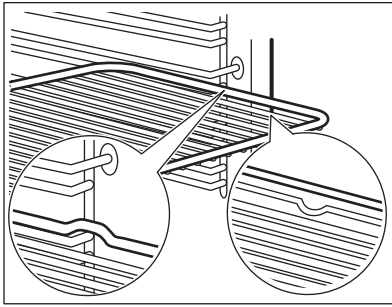

Baking tray/ Deep pan:

Push the baking tray / deep pan between the guide bars of the shelf support.

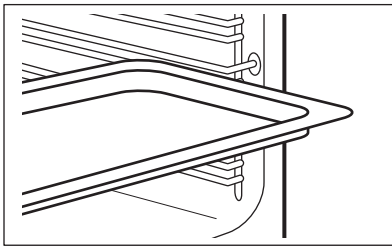

Wire shelf and baking tray / deep pan together:

Push the baking tray / deep pan between the guide bars of the shelf support and the wire shelf on the guide bars above.

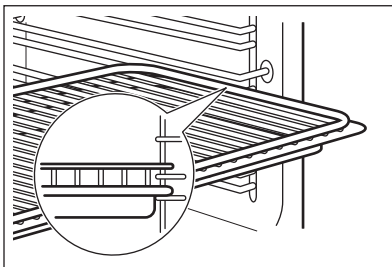

i Small indentation at the top increase safety. The indentations are also anti-tip devices. The high rim around the shelf prevents cookware from slipping of the shelf.

9.3 Telescopic Runners

i Keep the installation instructions for the telescopic runners for future use.

With telescopic runners you can put in and remove the shelves more easily.

! **CAUTION!**
Do not clean the telescopic runners in the dishwasher.
Do not lubricate the telescopic runners.

1. Pull out the right and left hand telescopic runners.

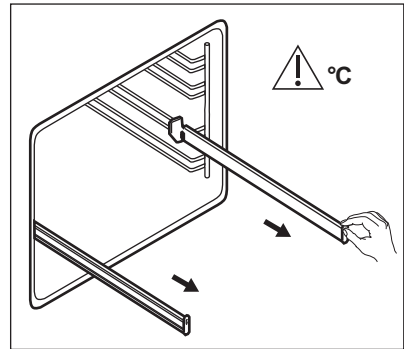

2. Put the wire shelf on the telescopic runners and carefully push them into the oven.

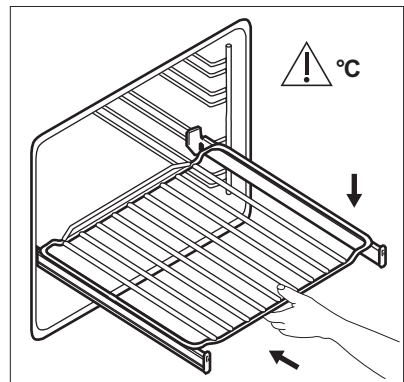

Make sure you push back the telescopic runners fully in the oven before you close the oven door.

10. ADDITIONAL FUNCTIONS

10.1 Using My Favourite Programme function

Use this function to save your favourite temperature and time settings for an oven function or programme.

1. Set the temperature and time for an oven function or programme.
 2. Touch and hold ☆ for more than three seconds. An acoustic signal sounds.
 3. Deactivate the appliance.
- **To activate the function** touch ☆. The appliance activates your favourite programme.

 When the function operates, you can change the time and temperature.

- **To deactivate the function** touch ⌚. The appliance deactivates your favourite programme.

10.2 Using the Child Lock

The Child Lock prevents an accidental operation of the oven.

1. You can turn on this function when the oven is off. Do not set a heating function.
2. Press and hold ⌚ for 3 seconds.
3. Press and hold ⌚ and ✓ at the same time for 2 seconds.

An acoustic signal sounds.
The display shows SAFE.
To turn off the Child Lock function repeat step 3.

10.3 Using the Function Lock

You can turn on the function only when the oven works.

The Function Lock prevents an accidental change of the oven function.

1. To turn on the function turn on the oven.
2. Turn on an oven function or setting.
3. Touch and hold ⌚ and ✓ at the same time for 2 seconds.

A signal sounds.
Lock comes on in the display.
To turn off the Function Lock repeat step 3.





 You can turn off the oven when the Function Lock is on. When you turn off the oven, the Function Lock turns off.



10.4 Using the settings menu

The settings menu lets you turn on or turn off functions in the main menu. The display shows SET and the number of the setting.

	Description	Value to set
1	RESIDUAL HEAT INDICATOR	ON / OFF
2	KEY TONE ¹⁾	CLICK / BEEP / OFF
3	FAULTY TONE	ON / OFF
4	DEMO MODE	Activation code: 2468
5	SERVICE MENU	-
6	RESTORE SETTINGS	YES / NO

¹⁾ It is not possible to deactivate the tone of the ON / OFF sensor field.

1. Press and hold  for 3 seconds. The display shows SET1 and "1" flashes.
2. Press  or  to set the setting.
3. Press OK.
4. Press  or  to change the value of the setting.
5. Press OK.

To exit the Settings menu, press  or press and hold .

10.5 Automatic Switch-off

For safety reasons the appliance deactivates automatically after some time if an oven function operates and you do not change any settings.

Temperature (°C)	Switch-off time (h)
30 - 115	12.5
120 - 195	8.5
200 - 245	5.5
250 - maximum	1.5

After the Automatic switch-off, touch a sensor field to operate the appliance again.



The Automatic switch-off does not work with the functions: core temperature sensor, Light, Slow Cooking, Duration, End, Time delay.

10.6 Brightness of the display

There are two modes of display brightness:

- Night brightness - when the appliance is deactivated, the brightness of the display is lower between 10 PM and 6 AM.
- Day brightness:
 - when the appliance is activated.
 - if you touch a sensor field during the night brightness (apart from ON / OFF), the display goes back to the day brightness mode for the next 10 seconds.
 - if the appliance is deactivated and you set the Minute Minder. When the Minute Minder function ends, the display goes back to the night brightness.

10.7 Cooling fan

When the oven operates, the cooling fan turns on automatically to keep the surfaces of the oven cool. If you turn off the oven, the cooling fan can continue to operate until the oven cools down.

10.8 Safety thermostat

Incorrect operation of the oven or defective components can cause dangerous overheating. To prevent this, the oven has a safety thermostat which interrupts the power supply. The oven turns on again automatically when the temperature drops.

11. HINTS AND TIPS



WARNING!
Refer to Safety chapters.



The temperature and baking times in the tables are guidelines only. They depend on the recipes and the quality and quantity of the ingredients used.

11.1 Cooking recommendations

The oven has five shelf positions.

Count the shelf positions from the bottom of the oven floor.

Your oven may bake or roast differently to the oven you had before. The below tables provide you with the standard settings for temperature, cooking time and shelf position.

If you cannot find the settings for a special recipe, look for the similar one.

The oven has a special system which circulates the air and constantly recycles the steam. With this system you can

cook in a steamy environment and keep the food soft inside and crusty outside. It decreases the cooking time and energy consumption.

Baking cakes

Do not open the oven door before 3/4 of the set cooking time is up.

If you use two baking trays at the same time, keep one empty level between them.

Cooking meat and fish

Use a deep pan for very fatty food to prevent the oven from stains that can be permanent.

Leave the meat for approximately 15 minutes before carving so that the juice does not seep out.

To prevent too much smoke in the oven during roasting, add some water into the deep pan. To prevent the smoke condensation, add water each time after it dries up.

Cooking times

Cooking times depend on the type of food, its consistency, and volume.

Initially, monitor the performance when you cook. Find the best settings (heat setting, cooking time, etc.) for your cookware, recipes and quantities when you use this appliance.

11.2 Baking and roasting

Cakes

Food	Conventional Cooking		True Fan Cooking		Time (min)	Comments
	Temperature (°C)	Shelf position	Temperature (°C)	Shelf position		
Whisked recipes	170	2	160	3 (2 and 4)	45 - 60	In a cake mould
Short-bread dough	170	2	160	3 (2 and 4)	20 - 30	In a cake mould
Buttermilk cheese-cake	170	1	165	2	80 - 100	In a 26 cm cake mould
Strudel	175	3	150	2	60 - 80	In a baking tray
Jam-tart	170	2	165	2 (left and right)	30 - 40	In a 26 cm cake mould
Christmas cake / Rich fruit cake	160	2	150	2	90 - 120	In a 20 cm cake mould. Preheat the oven for 10 minutes

Food	Conventional Cook- ing		True Fan Cooking		Time (min)	Com- ments
	Tempera- ture (°C)	Shelf po- sition	Tempera- ture (°C)	Shelf po- sition		
Plum cake	175	1	160	2	50 - 60	In a bread tin. Preheat the oven for 10 minutes
Biscuits / pastry stripes	140	3	140 - 150	3	25 - 45	In a bak- ing tray
Meringues - one level	120	3	120	3	80 - 100	In a bak- ing tray
Meringues - two lev- els	-	-	120	2 and 4	80 - 100	In a bak- ing tray. Preheat the oven for 10 minutes
Buns	190	3	190	3	12 - 20	In a bak- ing tray. Preheat the oven for 10 minutes
Eclairs - one level	190	3	170	3	25 - 35	In a bak- ing tray
Eclairs - two levels	-	-	170	2 and 4	35 - 45	In a bak- ing tray
Plate tarts	180	2	170	2	45 - 70	In a 20 cm cake mould
Rich fruit cake	160	1	150	2	110 - 120	In a 24 cm cake mould
Victoria sandwich	170	1	160	2 (left and right)	30 - 50	In a 20 cm cake mould

Bread and pizza

Food	Conventional Cooking		True Fan Cooking		Time (min)	Comments
	Temperature (°C)	Shelf position	Temperature (°C)	Shelf position		
White bread	190	1	190	1	60 - 70	1 - 2 pieces, 0.5 kg per piece. Preheat the oven for 10 minutes
Rye bread	190	1	180	1	30 - 45	In a bread tin
Bread rolls	190	2	180	2 (2 and 4)	25 - 40	6 - 8 rolls in a baking tray. Preheat the oven for 10 minutes
Pizza	230 - 250	1	230 - 250	1	10 - 20	In a baking tray or a deep pan. Preheat the oven for 10 minutes
Scones	200	3	190	3	10 - 20	In a baking tray. Preheat the oven for 10 minutes

Flans

Food	Conventional Cooking		True Fan Cooking		Time (min)	Comments
	Temperature (°C)	Shelf position	Temperature (°C)	Shelf position		
Pasta flan	200	2	180	2	40 - 50	In a mould
Vegetable flan	200	2	175	2	45 - 60	In a mould

Food	Conventional Cooking		True Fan Cooking		Time (min)	Comments
	Temperature (°C)	Shelf position	Temperature (°C)	Shelf position		
Quiches	180	1	180	1	50 - 60	In a mould. Preheat the oven for 10 minutes
Lasagne	180 - 190	2	180 - 190	2	25 - 40	In a mould. Preheat the oven for 10 minutes
Cannelloni	180 - 190	2	180 - 190	2	25 - 40	In a mould. Preheat the oven for 10 minutes

Meat

Food	Conventional Cooking		True Fan Cooking		Time (min)	Comments
	Temperature (°C)	Shelf position	Temperature (°C)	Shelf position		
Beef	200	2	190	2	50 - 70	On a wire shelf
Pork	180	2	180	2	90 - 120	On a wire shelf
Veal	190	2	175	2	90 - 120	On a wire shelf
English roast beef, rare	210	2	200	2	50 - 60	On a wire shelf
English roast beef, medium	210	2	200	2	60 - 70	On a wire shelf
English roast beef, well done	210	2	200	2	70 - 75	On a wire shelf

Food	Conventional Cooking		True Fan Cooking		Time (min)	Comments
	Temperature (°C)	Shelf position	Temperature (°C)	Shelf position		
Shoulder of pork	180	2	170	2	120 - 150	With rind
Shin of pork	180	2	160	2	100 - 120	2 pieces
Lamb	190	2	175	2	110 - 130	Leg
Chicken	220	2	200	2	70 - 85	Whole
Turkey	180	2	160	2	210 - 240	Whole
Duck	175	2	220	2	120 - 150	Whole
Goose	175	2	160	1	150 - 200	Whole
Rabbit	190	2	175	2	60 - 80	Cut in pieces
Hare	190	2	175	2	150 - 200	Cut in pieces
Pheasant	190	2	175	2	90 - 120	Whole

Fish

Food	Conventional Cooking		True Fan Cooking		Time (min)	Comments
	Temperature (°C)	Shelf position	Temperature (°C)	Shelf position		
Trout / Sea bream	190	2	175	2	40 - 55	3 - 4 fish
Tuna fish / Salmon	190	2	175	2	35 - 60	4 - 6 fillets

11.3 Grilling

Set the maximum temperature.

Preheat the oven for 3 minutes.

Use the fourth shelf position.

Food	Quantity		Time (min)	
	Pieces	Quantity (kg)	1st side	2nd side
Fillet steaks	4	0.8	12 - 15	12 - 14

Food	Quantity		Time (min)	
	Pieces	Quantity (kg)	1st side	2nd side
Beef steaks	4	0.6	10 - 12	6 - 8
Sausages	8	-	12 - 15	10 - 12
Pork chops	4	0.6	12 - 16	12 - 14
Chicken (cut in 2)	2	1	30 - 35	25 - 30
Kebabs	4	-	10 - 15	10 - 12
Breast of chicken	4	0.4	12 - 15	12 - 14
Hamburger	6	0.6	20 - 30	-
Fish fillet	4	0.4	12 - 14	10 - 12
Toasted sandwiches	4 - 6	-	5 - 7	-
Toast	4 - 6	-	2 - 4	2 - 3

11.4 Turbo Grilling

Use the first or the second shelf position.

Beef

Preheat the oven.

To calculate the roasting time multiple the time given in the table below by the centimetres of thickness of the fillet.

Food	Temperature (°C)	Time (min)
Roast beef or fillet, rare	190 - 200	5 - 6
Roast beef or fillet, medium	180 - 190	6 - 8
Roast beef or fillet, well done	170 - 180	8 - 10

Pork

Food	Temperature (°C)	Time (min)
Shoulder, neck, ham joint, 1 - 1.5 kg	160 - 180	90 - 120

Food	Temperature (°C)	Time (min)
Chop, spare rib, 1 - 1.5 kg	170 - 180	60 - 90
Meat loaf, 0.75 - 1 kg	160 - 170	50 - 60
Pork knuckle (pre-cooked), 0.75 - 1 kg	150 - 170	90 - 120

Veal

Food	Temperature (°C)	Time (min)
Roast veal, 1 kg	160 - 180	90 - 120
Knuckle of veal, 1.5 - 2 kg	160 - 180	120 - 150

Lamb

Food	Temperature (°C)	Time (min)
Leg of lamb, roast lamb, 1 - 1.5 kg	150 - 170	100 - 120
Saddle of lamb, 1 - 1.5 kg	160 - 180	40 - 60

Poultry

Food	Temperature (°C)	Time (min)
Poultry portions, 0.2 - 0.25 kg each	200 - 220	30 - 50
Chicken, half, 0.4 - 0.5 kg each	190 - 210	35 - 50
Chicken, poulard, 1 - 1.5 kg	190 - 210	50 - 70

Food	Temperature (°C)	Time (min)
Duck, 1.5 - 2 kg	180 - 200	80 - 100
Goose, 3.5 - 5 kg	160 - 180	120 - 180
Turkey, 2.5 - 3.5 kg	160 - 180	120 - 150
Turkey, 4 - 6 kg	140 - 160	150 - 240

Fish (steamed)

Food	Temperature (°C)	Time (min)
Whole fish, 1 - 1.5 kg	210 - 220	40 - 60

11.5 Moist Fan Baking

For the best results follow suggestions listed in the table below.

Food	Accessories	Temperature (°C)	Shelf position	Time (min)
Sweet rolls, 12 pieces	baking tray or dripping pan	180	2	20 - 30
Rolls, 9 pieces	baking tray or dripping pan	180	2	30 - 40
Pizza, frozen, 0.35 kg	wire shelf	220	2	10 - 15
Swiss roll	baking tray or dripping pan	170	2	25 - 35
Brownie	baking tray or dripping pan	175	3	25 - 30
Soufflé, 6 pieces	ceramic ramekins on wire shelf	200	3	25 - 30
Sponge flan base	flan base tin on wire shelf	180	2	15 - 25
Victoria Sandwich	baking dish on wire shelf	170	2	40 - 50

Food	Accessories	Temperature (°C)	Shelf position	Time (min)
Poached fish, 0.3 kg	baking tray or dripping pan	180	3	20 - 25
Whole fish, 0.2 kg	baking tray or dripping pan	180	3	25 - 35
Fish fillet, 0.3 kg	pizza pan on wire shelf	180	3	25 - 30
Poached meat, 0.25 kg	baking tray or dripping pan	200	3	35 - 45
Shashlik, 0.5 kg	baking tray or dripping pan	200	3	25 - 30
Cookies, 16 pieces	baking tray or dripping pan	180	2	20 - 30
Macaroons, 20 pieces	baking tray or dripping pan	180	2	25 - 35
Muffins, 12 pieces	baking tray or dripping pan	170	2	30 - 40
Savory pastry, 16 pieces	baking tray or dripping pan	180	2	25 - 30
Short crust biscuits, 20 pieces	baking tray or dripping pan	150	2	25 - 35
Tartlets, 8 pieces	baking tray or dripping pan	170	2	20 - 30
Poached vegetables, 0.4 kg	baking tray or dripping pan	180	3	35 - 45
Vegetarian omelette	pizza pan on wire shelf	200	3	25 - 30
Vegetables, mediterranean 0.7 kg	baking tray or dripping pan	180	4	25 - 30

11.6 Slow Cooking

Use this function to prepare lean, tender pieces of meat and fish with core temperatures no more than 65 °C. This function is not applicable to such recipes as pot roast or fatty roast pork. You can use the core temperature sensor to guarantee that the meat has the correct core temperature (see the table for the core temperature sensor).

In the first 10 minutes you can set an oven temperature between 80 °C and 150 °C. The default is 90 °C. After the temperature is set, the oven continues to cook at 80 °C. Do not use this function for poultry.



Always cook without a lid when you use this function.

1. Sear the meat in a pan on the hob on a very high setting for 1 - 2 minutes on each side.

2. Put the meat together with the hot roasting pan in the oven and on the wire shelf.
3. Put the core temperature sensor into the meat.
4. Select the function: Slow Cooking and set the correct end core temperature.

Set the temperature to 120 °C.

Food	Time (min)	Shelf position
Roast beef, 1 - 1.5 kg	120 - 150	1

Food	Time (min)	Shelf position
Fillet of beef, 1 - 1.5 kg	90 - 150	3
Roast veal, 1 - 1.5 kg	120 - 150	1
Steaks, 0.2 - 0.3 kg	20 - 40	3

11.7 Defrost

Food	Quantity (kg)	Defrosting time (min)	Further defrosting time (min)	Comments
Chicken	1.0	100 - 140	20 - 30	Place chicken on an up-turned saucer placed on a large plate. Turn half-way through.
Meat	1.0	100 - 140	20 - 30	Turn halfway through.
	0.5	90 - 120		
Trout	0.15	25 - 35	10 - 15	-
Strawberries	0.3	30 - 40	10 - 20	-
Butter	0.25	30 - 40	10 - 15	-
Cream	2 x 0.2	80 - 100	10 - 15	Cream can also be whipped when still slightly frozen in places.
Gateau	1.4	60	60	-

11.8 Preserving

Use only preserve jars of the same dimensions available on the market.

Do not use jars with twist-off and bayonet type lids or metal tins.

Use the first shelf from the bottom for this function.

Put no more than six one-litre preserve jars on the baking tray.

Fill the jars equally and close with a clamp.

The jars cannot touch each other.

Put approximately 1/2 litre of water into the baking tray to give sufficient moisture in the oven.

When the liquid in the jars starts to simmer (after approximately 35 - 60 minutes with one-litre jars), stop the oven or decrease the temperature to 100 °C (see the table).

Soft fruit

Food	Temperature (°C)	Cooking time until simmering (min)	Continue to cook at 100 °C (min)
Strawberries / Blueberries / Raspberries / Ripe gooseberries	160 - 170	35 - 45	-

Stone fruit

Food	Temperature (°C)	Cooking time until simmering (min)	Continue to cook at 100 °C (min)
Pears / Quinces / Plums	160 - 170	35 - 45	10 - 15

Vegetables

Food	Temperature (°C)	Cooking time until simmering (min)	Continue to cook at 100 °C (min)
Carrots ¹⁾	160 - 170	50 - 60	5 - 10
Cucumbers	160 - 170	50 - 60	-
Mixed pickles	160 - 170	50 - 60	5 - 10
Kohlrabi / Peas / Asparagus	160 - 170	50 - 60	15 - 20

¹⁾ Leave standing in the oven after it is deactivated.

11.9 Drying

Cover trays with grease proof paper or baking parchment.

For a better result, stop the oven halfway through the drying time, open the door

and let it cool down for one night to complete the drying.

Vegetables

For one tray use the third shelf position.

For 2 trays use the first and fourth shelf position.

Food	Temperature (°C)	Time (h)
Beans	60 - 70	6 - 8
Peppers	60 - 70	5 - 6
Vegetables for sour	60 - 70	5 - 6
Mushrooms	50 - 60	6 - 8
Herbs	40 - 50	2 - 3

Fruit

Food	Temperature (°C)	Time (h)	Shelf position	
			1 position	2 positions
Plums	60 - 70	8 - 10	3	1 / 4
Apricots	60 - 70	8 - 10	3	1 / 4
Apple slices	60 - 70	6 - 8	3	1 / 4
Pears	60 - 70	6 - 9	3	1 / 4

11.10 Core temperature sensor table

Food	Food core temperature (°C)
Roast veal	75 - 80
Veal knuckle	85 - 90
English roast beef, rare	45 - 50
English roast beef, medium	60 - 65
English roast beef, well done	70 - 75
Shoulder of pork	80 - 82

Food	Food core temperature (°C)
Shin of pork	75 - 80
Lamb	70 - 75
Chicken	98
Hare	70 - 75
Trout / Sea bream	65 - 70
Tuna fish / Salmon	65 - 70

11.11 Information for test institutes

Tests according to IEC 60350-1.

Food	Function	Accessories	Shelf position	Temperature (°C)	Time (min)	Comments
Small cake	Conventional Cooking	Baking tray	3	170	20 - 30	Put 20 small cakes per one baking tray.
Small cake	True Fan Cooking / Fan Cooking	Baking tray	3	150 - 160	20 - 35	Put 20 small cakes per one baking tray.
Small cake	True Fan Cooking / Fan Cooking	Baking tray	2 and 4	150 - 160	20 - 35	Put 20 small cakes per one baking tray.

Food	Function	Accessories	Shelf position	Temperature (°C)	Time (min)	Comments
Apple pie	Conventional Cooking	Wire shelf	2	180	70 - 90	Use 2 tins (20 cm diameter), diagonally shifted.
Apple pie	True Fan Cooking / Fan Cooking	Wire shelf	2	160	70 - 90	Use 2 tins (20 cm diameter), diagonally shifted.
Fatless-ponge cake	Conventional Cooking	Wire shelf	2	170	40 - 50	Use a cake mould (26 cm diameter). Preheat the oven for 10 minutes.
Fatless-ponge cake	True Fan Cooking / Fan Cooking	Wire shelf	2	160	40 - 50	Use a cake mould (26 cm diameter). Preheat the oven for 10 minutes.
Fatless-ponge cake	True Fan Cooking / Fan Cooking	Wire shelf	2 and 4	160	40 - 60	Use a cake mould (26 cm diameter). Diagonally shifted. Preheat the oven for 10 minutes.
Short bread	True Fan Cooking / Fan Cooking	Baking tray	3	140 - 150	20 - 40	-
Short bread	True Fan Cooking / Fan Cooking	Baking tray	2 and 4	140 - 150	25 - 45	-
Short bread	Conventional Cooking	Baking tray	3	140 - 150	25 - 45	-
Toast 4 - 6 pieces	Grilling	Wire shelf	4	max.	2 - 3 minutes first side; 2 - 3 minutes second side	Preheat the oven for 3 minutes.

Food	Function	Accessories	Shelf position	Temperature (°C)	Time (min)	Comments
Beef burger 6 pieces, 0.6 kg	Grilling	Wire shelf and dripping pan	4	max.	20 - 30	Put the wire shelf on the fourth level and the dripping pan on the third level of the oven. Turn the food halfway through the cooking time. Preheat the oven for 3 minutes.

12. CARE AND CLEANING



WARNING!
Refer to Safety chapters.

12.1 Notes on cleaning

Clean the front of the oven with a soft cloth with warm water and a mild cleaning agent.

To clean metal surfaces, use a dedicated cleaning agent.

Clean the oven interior after each use. Fat accumulation or other food remains may result in a fire. The risk is higher for the grill pan.

Clean all accessories after each use and let them dry. Use a soft cloth with warm water and a cleaning agent. Do not clean the accessories in the dishwasher.

Clean stubborn dirt with a special oven cleaner. Do not apply oven cleaner on the catalytic surfaces.

If you have nonstick accessories, do not clean them using aggressive agents, sharp-edged objects or a dishwasher. It can cause damage to the nonstick coating.

Moisture can condense in the oven or on the door glass panels. To decrease the condensation, operate the oven for 10 minutes before cooking. Clean the moisture from the cavity after each use.

12.2 Stainless steel or aluminium ovens

Clean the oven door with a damp cloth or sponge only. Dry it with a soft cloth.

Do not use steel wool, acids or abrasive materials as they can damage the oven surface. Clean the oven control panel with the same precautions.

12.3 Cleaning the door gasket

Regularly do a check of the door gasket. The door gasket is around the frame of the oven cavity. Do not use the oven if the door gasket is damaged. Contact an Authorised Service Centre.

To clean the door gasket, refer to the general information about cleaning.

12.4 Removing the shelf supports / catalytic panels

To clean the oven, remove the shelf supports / catalytic panels.



CAUTION!
Be careful when you remove the shelf supports. The catalytic panels are not attached to the oven walls and can fall out when you remove the shelf supports.

1. Pull the front of the shelf support away from the side wall. Hold the rear shelf runners and catalytic panel in place with the other hand.

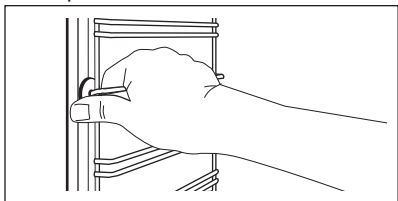

2. Pull the rear end of the shelf support away from the side wall and remove it.

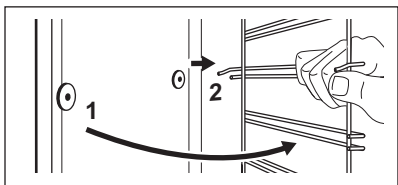

Install the removed accessories in the opposite sequence.

- i** The retaining pins on the telescopic runners must point to the front.

12.5 Catalysis



CAUTION!

Do not clean the catalytic surface with oven sprays, abrasive cleaning agents, soap or other cleaning agents. This will damage the catalytic surface.

Remove all accessories and removable shelf supports.

The walls and the top of the cavity are catalytic-coated. They absorb fat and food particles at high temperature without smell.

To support this self-cleaning process heat the appliance without any food regularly.

- i** Spots or discolouration of the catalytic surface has no effect on catalytic properties.

1. Touch  again and again until the display shows "Cata" and the duration of the cleaning procedure (1 hour).

You cannot set the Duration, but you can use the End function to delay the start of the cleaning procedure.

An acoustic signal sounds after the time ends. The appliance deactivates.

2. Touch a sensor field or open the oven door to stop the acoustic signal.
3. Clean the bottom of the appliance with a soft and moist sponge.

12.6 Removing and installing door

The oven door has three glass panels. You can remove the oven door and the internal glass panels to clean them. Read the whole "Removing and installing door" instruction before you remove the glass panels.

- i** The oven door may close if you try to remove the glass panels before you remove the oven door.



CAUTION!

Do not use the oven without the glass panels.

1. Fully open the door and find the hinge to the right side of the door.
2. Use a screwdriver to lift and turn fully the right side hinge lever.

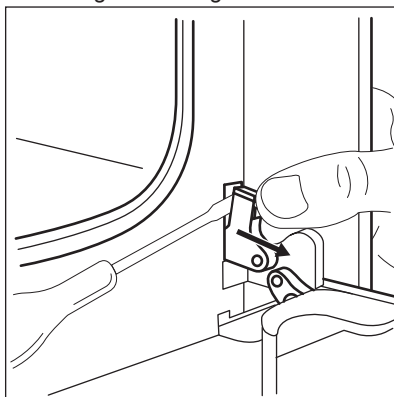

3. Find the hinge to the left side of the door.

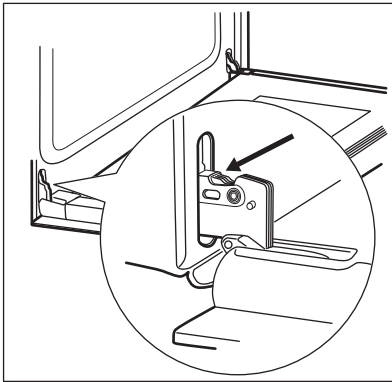

4. Lift and turn the lever fully on the left hinge.

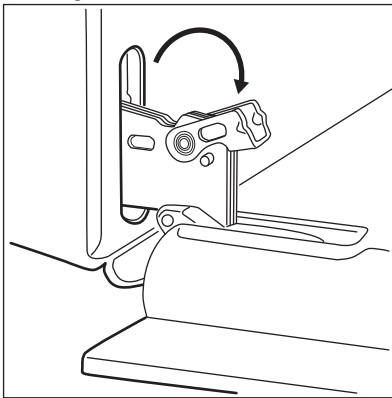

5. Close the oven door halfway to the first opening position. Then lift and pull forward and remove the door from its seat.

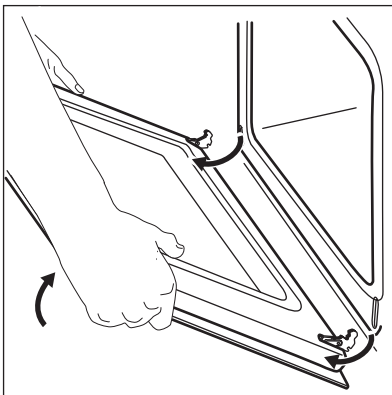

6. Put the door on a soft cloth on a stable surface.

7. Hold the door trim (B) on the top edge of the door at the two sides and push inwards to release the clip seal.

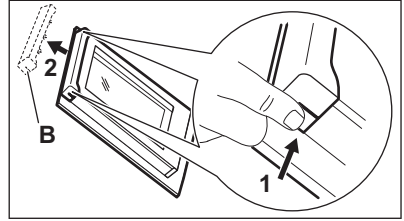

8. Pull the door trim to the front to remove it.
 9. Hold the door glass panels by their top edge and carefully pull them out one by one. Start from the top panel. Make sure the glass slides out of the supports completely.

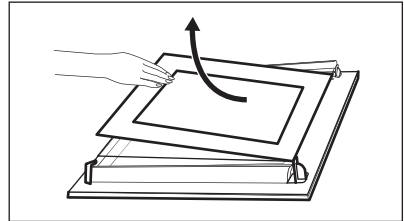

10. Clean the glass panels with water and soap. Dry the glass panels carefully. Do not clean the glass panels in the dishwasher.

When the cleaning is completed, install the glass panels and the oven door.

Make sure that you put the glass panels (A and B) back in the correct sequence. Check for the symbol / printing on the side of the glass panel, each of the glass panels looks different to make the disassembly and assembly easier.

When installed correctly the door trim clicks.

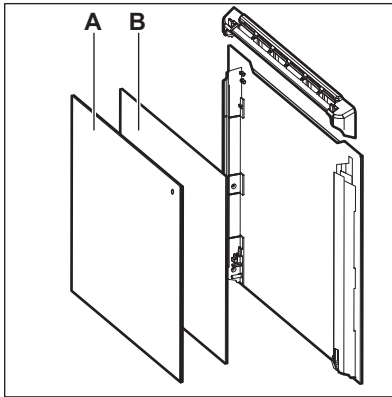

Make sure that you install the middle panel of glass in the seats correctly.

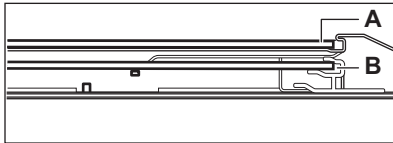

1. Turn off the oven.
Wait until the oven is cooled down.
2. Disconnect the oven from the mains.
3. Put a cloth on the bottom of the cavity.



CAUTION!

Always hold the halogen lamp with a cloth to prevent grease residue from burning on the lamp.

The back lamp

1. Turn the lamp glass cover to remove it.
2. Clean the glass cover.
3. Replace the lamp with a suitable 300 °C heat-resistant lamp.
4. Install the glass cover.

12.7 Replacing the lamp



WARNING!

Risk of electric shock.
The lamp can be hot.

13. TROUBLESHOOTING





WARNING!

Refer to Safety chapters.

13.1 What to do if...

Problem	Possible cause	Remedy
You cannot activate or operate the oven.	The oven is not connected to an electrical supply or it is connected incorrectly.	Check if the oven is correctly connected to the electrical supply (refer to the connection diagram if available).
The oven does not heat up.	The oven is deactivated.	Activate the oven.
The oven does not heat up.	The clock is not set.	Set the clock.
The oven does not heat up.	The necessary settings are not set.	Make sure that the settings are correct.

Problem	Possible cause	Remedy
The oven does not heat up.	The automatic switch-off is activated.	Refer to "Automatic switch-off".
The oven does not heat up.	The Child Lock is on.	Refer to "Using the Child Lock".
The oven does not heat up.	The fuse is blown.	Make sure that the fuse is the cause of the malfunction. If the fuse is blown again and again, contact a qualified electrician.
The lamp does not operate.	The lamp is defective.	Replace the lamp.
The display does not show the time during the off status.	The display is deactivated.	Touch  and  at the same time to activate the display again.
The core temperature sensor does not operate.	The plug of the core temperature sensor is not correctly installed into the socket.	Put the plug of the core temperature sensor as far as possible into the socket.
It takes too long to cook the dishes or they cook too quickly.	The temperature is too low or too high.	Adjust the temperature if necessary. Follow the advice in the user manual.
Steam and condensation settle on the food and in the cavity of the oven.	You left the dish in the oven for too long.	Do not leave the dishes in the oven for longer than 15 - 20 minutes after the cooking process ends.
The display shows "C2".	You want to start the Catalysis or Defrost function, but you did not remove the core temperature sensor plug from the socket.	Remove the core temperature sensor plug from the socket.
The display shows "C3".	The cleaning function does not operate. You did not fully close the door, or the door lock is defective.	Fully close the door.
The display shows an error code that is not in this table.	There is an electrical fault.	<ul style="list-style-type: none"> Deactivate the oven with the house fuse or the safety switch in the fuse box and activate it again. If the display shows the error code again, contact the Customer Care Department.

Problem	Possible cause	Remedy
The appliance is activated and does not heat up. The fan does not operate. The display shows "Demo".	The demo mode is activated.	Refer to "Using the settings menu" in "Additional functions" chapter.

13.2 Service data

If you cannot find a solution to the problem yourself, contact your dealer or an Authorised Service Centre.

The necessary data for the service centre is on the rating plate. The rating

plate is on the front frame of the oven cavity. Do not remove the rating plate from the oven cavity.

We recommend that you write the data here:	
Model (MOD.)
Product number (PNC)
Serial number (S.N.)

14. INSTALLATION

⚠ WARNING!
Refer to Safety chapters.

14.1 Building In

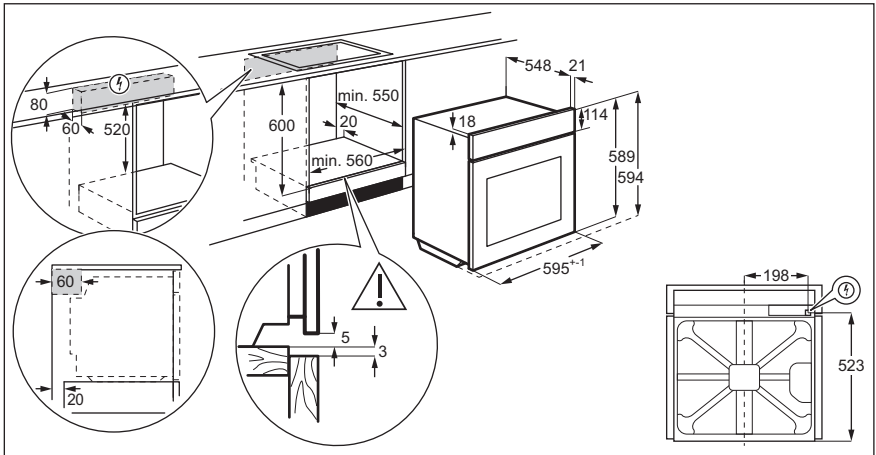

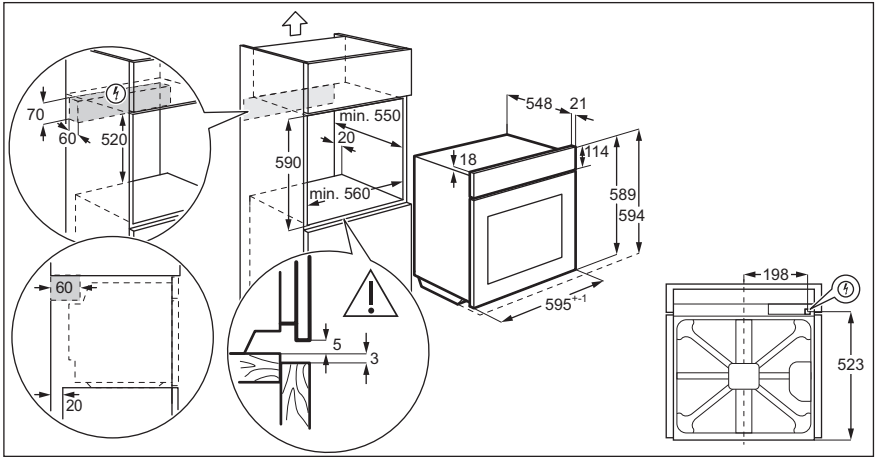

14.2 Securing the appliance to the cabinet

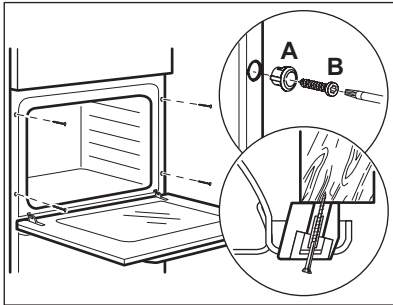

14.3 Electrical installation

i The manufacturer is not responsible if you do not follow the safety precautions from the Safety chapters.

This appliance is supplied with a main plug and a main cable.

14.4 Cable

Cable types applicable for installation or replacement:

H07 RN-F, H05 RN-F, H05 RRF, H05 VV-F, H05 V2V2-F (T90), H05 BB-F

For the section of the cable refer to the total power on the rating plate. You can also refer to the table:

Total power (W)	Section of the cable (mm ²)
maximum 1380	3 x 0.75
maximum 2300	3 x 1
maximum 3680	3 x 1.5

The earth cord (green / yellow cable) must be 2 cm longer than phase and neutral cables (blue and brown cables).

15. ENERGY EFFICIENCY

15.1 Product Fiche and information according to EU 65-66/2014

Supplier's name

Electrolux

Model identification	EOE7C31V EOE7C31X EOE7C31Z	
Energy Efficiency Index	81.2	
Energy efficiency class	A+	
Energy consumption with a standard load, conventional mode	0.93 kWh/cycle	
Energy consumption with a standard load, fan-forced mode	0.69 kWh/cycle	
Number of cavities	1	
Heat source	Electricity	
Volume	72 l	
Type of oven	Built-In Oven	
Mass	EOE7C31V	31.0 kg
	EOE7C31X	31.0 kg
	EOE7C31Z	31.0 kg

EN 60350-1 - Household electric cooking appliances - Part 1: Ranges, ovens, steam ovens and grills - Methods for measuring performance.

15.2 Energy saving



The oven contains features which help you save energy during everyday cooking.

General hints

Make sure that the oven door is closed properly when the oven operates. Do not open the door too often during cooking. Keep the door gasket clean and make sure it is well fixed in its position.

Use metal dishes to improve energy saving.

When possible, do not preheat the oven before you put the food inside.

When the cooking duration is longer than 30 minutes, reduce the oven temperature to minimum 3 - 10 minutes before the end of the cooking time, depending on the duration of the cooking. The residual heat inside the oven will continue to cook.

Use the residual heat to warm up other dishes.

Keep breaks between baking as short as possible when you prepare few dishes at one time.

Cooking with fan

When possible, use the cooking functions with fan to save energy.

Residual heat

If a programme with the Duration or End Time selection is activated and the cooking time is longer than 30 minutes, the heating elements automatically deactivate earlier in some oven functions.

The fan and lamp continue to operate.

Keep food warm

Choose the lowest possible temperature setting to use residual heat and keep a meal warm. The residual heat indicator or temperature appears on the display.

Cooking with the lamp off



Turn off the lamp during cooking. Turn it on only when you need it.

Moist Fan Baking

Function designed to save energy during cooking.

When you use this function the lamp automatically turns off after 30 seconds. You may turn on the lamp again but this action will reduce the expected energy savings.

Deactivating the display

You can turn off the display. Press and hold  and  at the same time. To turn it on repeat this step.

16. ENVIRONMENTAL CONCERNS

Recycle materials with the symbol . Put the packaging in relevant containers to recycle it. Help protect the environment and human health by recycling waste of electrical and electronic appliances. Do not dispose of

appliances marked with the symbol  with the household waste. Return the product to your local recycling facility or contact your municipal office.

www.electrolux.com/shop



867355111-A-432018

